

Data sheet | Item number: 733-102/037-000

1-conductor female plug; 100% protected against mismatching; Locking lever;
0.5 mm²; Pin spacing 2.5 mm; 2-pole



733-102/037-000



RoHS Compliant

[BOMcheck.net](https://www.bomcheck.net)

Color:

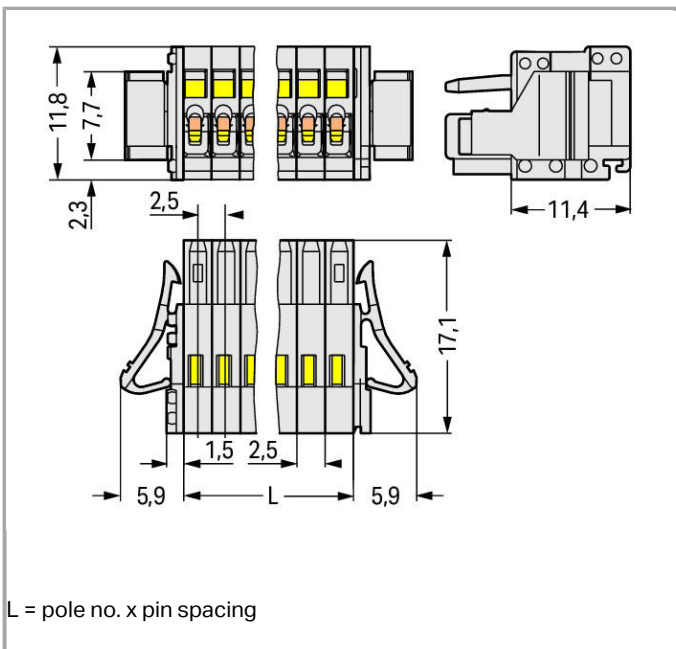
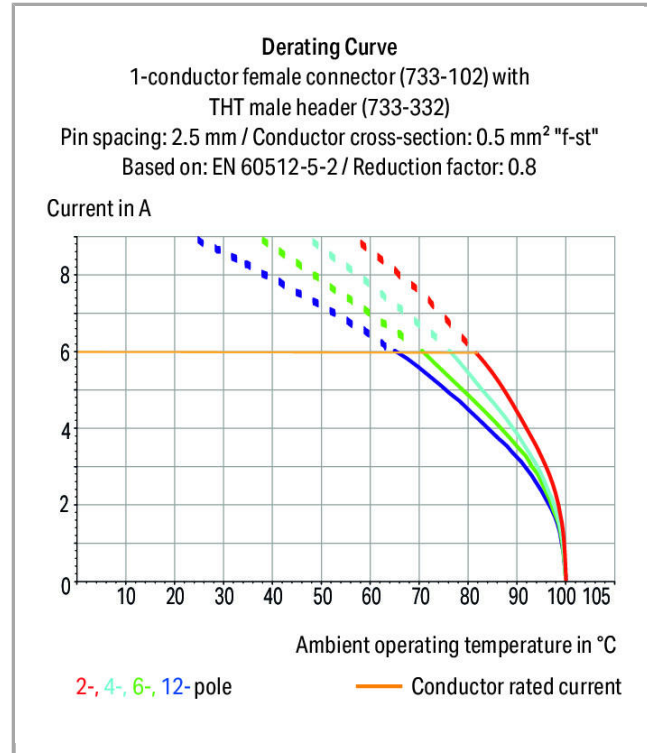



Item description

- Universal connection for all conductor types
- Easy cable pre-assembly and on-unit wiring via vertical and horizontal CAGE CLAMP® actuation
- Strain relief plates for factory and in-the-field assembly
- 100% protected against mismatching
- Coding via coding fingers

Safety information 1:

The *MULTI CONNECTION SYSTEM (MCS)* is designed without breaking capacity for compliance with DIN EN 61984. When used as intended, MCS Connectors shall not be connected/disconnected when live or under load. The circuit design should ensure header pins, which can be touched, are not live when unmated.

Data

Electrical data

Ratings per IEC/EN 60664-1

Rated voltage (III / 3)	100 V
Rated impulse voltage (III / 3)	2.5 kV
Rated voltage (III / 2)	160 V
Rated impulse voltage (III / 2)	2.5 kV
Rated voltage (II / 2)	320 V
Rated impulse voltage (II / 2)	2.5 kV
Rated current	6 A

Approvals per UL 1059

Rated voltage UL (Use Group B)	150 V
Rated current UL (Use Group B)	4 A

Approvals per CSA

Rated voltage CSA (Use Group B)	150 V
Rated current CSA (Use Group B)	4 A

Connection data

Connection technology	CAGE CLAMP®
Actuation type	Operating tool
Solid conductor	0.08 ... 0.5 mm ² / 28 ... 20 AWG
Fine-stranded conductor	0.08 ... 0.5 mm ² / 28 ... 20 AWG
Fine-stranded conductor with ferrule with plastic collar	0.25 ... 0.34 mm ²
Fine-stranded conductor with ferrule without plastic collar	0.25 ... 0.34 mm ²



Strip length	5 ... 6 mm / 0.2 ... 0.24 inch
No. of poles	2
Total number of connection points	2
Total number of potentials	2
Number of connection types	1
Number of levels	1
Conductor entry direction to mating direction	0°

Geometrical Data

Pin spacing	2.5 mm / 0.098 inch
Width	16.8 mm / 0.661 inch
Height	11.8 mm / 0.465 inch
Depth	17.1 mm / 0.673 inch

Plug connection

Contact type (pluggable connector)	Female connector/socket
Connector connection type	for conductors
Mismating protection	Yes
Locking of plug-in connection	locking lever

Material Data

Color	light gray
Material group	I
Insulating material	Polyamide 66 (PA 66)
Flammability class per UL94	V0
Clamping spring material	Chrome nickel spring steel (CrNi)
Contact material	Copper alloy
Contact plating	tin-plated
Fire load	0.032 MJ
Weight	1.45 g

Environmental Requirements

Limit temperature range	-60 ... +100 °C
-------------------------	-----------------

Commercial data

Product Group	3 (Multi Conn. System)
Country of origin	DE
GTIN	4045454215491
Customs Tariff No.	85366990990

Approvals / Certificates

UL-Approvals







Logo	Approval	Additional Approval Text	Certificate name
	UL Underwriters Laboratories Inc.	UL 1059	20190122-E45172

Compatible products

check







	Item no.: 735-500 Test pin; 1 mm Ø; with solder connection for test wire	735-500
--	--	---------

tools

	Item no.: 210-251 Operating tool; for female and male connectors with CAGE CLAMP® connection; MCS MINI & MICRO	210-251
	Item no.: 210-719 Operating tool with partially insulated shaft; Type 1, blade (2.5 x 0.4) mm	210-719
	Item no.: 233-331 Operating tool; for female and male connectors with CAGE CLAMP® connection; insulated	233-331
	Item no.: 233-332 Operating tool; for 233 and 733 Series; of insulating material	233-332
	Item no.: 233-335 Operating tool; for 233 and 733 Series	233-335
	Item no.: 733-130 Operating tool; for male and female connectors with CAGE CLAMP®; loose	733-130
	Item no.: 733-191 Operating tool; for male and female connectors with CAGE CLAMP®; loose	733-191

Marking accessories

Item no.: 210-331/250-202 Marking strips; as a DIN A4 sheet; MARKED; 1-16 (400x); Height of marker strip: 2.3 mm/0.091 in; Strip length 182 mm; Horizontal marking; Self-adhesive	210-331 / 250-202
Item no.: 210-331/250-204 Marking strips; as a DIN A4 sheet; MARKED; 17-32 (400x); Height of marker strip: 2.3 mm/0.091 in; Strip length 182 mm; Horizontal marking; Self-adhesive	210-331 / 250-204
Item no.: 210-331/250-206 Marking strips; as a DIN A4 sheet; MARKED; 33-48 (400x); Height of marker strip: 2.3 mm/0.091 in; Strip length 182 mm; Horizontal marking; Self-adhesive	210-331 / 250-206

	Item no.: 210-331/250-207 Marking strips; as a DIN A4 sheet; MARKED; 1-48 (100x); Height of marker strip: 2.3 mm/0.091 in; Strip length 182 mm; Horizontal marking; Self-adhesive	210-331 <i>/250-207</i>
ferrule		
	Item no.: 216-131 Ferrule; Sleeve for 0.25 mm ² / AWG 24; uninsulated; electro-tin plated	216-131
	Item no.: 216-132 Ferrule; Sleeve for 0.34 mm ² / AWG 24; uninsulated; electro-tin plated	216-132
	Item no.: 216-151 Ferrule; Sleeve for 0.25 mm ² / AWG 24; uninsulated; electro-tin plated	216-151
	Item no.: 216-152 Ferrule; Sleeve for 0.34 mm ² / AWG 24; uninsulated; electro-tin plated	216-152
	Item no.: 216-301 Ferrule; Sleeve for 0.25 mm ² / AWG 24; insulated; electro-tin plated	216-301
	Item no.: 216-302 Ferrule; Sleeve for 0.34 mm ² / 22 AWG; insulated; electro-tin plated	216-302
	Item no.: 216-321 Ferrule; Sleeve for 0.25 mm ² / AWG 24; insulated; electro-tin plated	216-321
	Item no.: 216-322 Ferrule; Sleeve for 0.34 mm ² / 22 AWG; insulated; electro-tin plated	216-322
Strain relief plate		
	Item no.: 734-127 Strain relief plate	734-127

Downloads

CAD/CAE - Smart Data

CAD data

	URL	Download
3D Download 733-102/037-000		

Subject to changes.